

HP Designjet T1100 MFP

A trusted choice for demanding professionals

Whether you're working with line drawings, maps, images, or posters, this HP multifunction printer helps you copy, scan, and print all your large-format documents quickly using one convenient, integrated device. And with HP Vivera inks, you get high-quality results every time.



Superior color and black-and-white copy, scan, and print results

- **Scan any document and see excellent results with 3 CCD camera scanning technology.** With up to 9600 dpi resolution and 0.1% line accuracy, you'll achieve a high level of detail, matching your originals.
- **Copy anything from line drawings to complex maps or images.** See impressive color accuracy—including black and gray tones—over a range of applications.
- **Professional prints—HP Vivera inks with the Three-black ink set produce a wide range of colors and fine detail.** With the addition of gray ink in the HP Three-black ink set, you achieve more accurate color, dark blacks, and true neutral grays, so prints have smooth area fills, more depth, and more subtle contrasts.
- **Fast-drying, smudge-resistant prints—HP Vivera inks are designed together with a range of Original HP media.** HP Vivera inks achieve excellent dry times, producing prints with outstanding smudge-resistance on over 20 Original HP media substrates.

Quickly and effectively performs three functions in one

- **This HP MFP scans, copies, and prints your projects quickly, so you're back to business in no time.** Create one A1 (D)-sized copy up to four times faster than with the HP Designjet 820 MFP¹—and realize even faster speeds when producing numerous high-quality copies of your original documents.
- **Print and scan quickly—fast processing speed makes short work of large files.** The HP Designjet T1100 MFP comes standard with an integrated, embedded operating system and a fast Intel[®] Pentium[®] IV processor. In addition, with this printer's in-printer processing architecture and 40 GB hard disk drive, files are processed in the printer rather than on your workstation, so you can send a file reliably to the printer and get back to work quickly.
- **Advanced copy features simplify tasks and expand your options.** Skew is rarely a problem when you use the auto-alignment option to load and preview your original. Use the nesting option to save media, and make extra-large enlargements easily with the paneling option. You can also perform batch scanning with auto-naming and track your output by using the integrated accounting features.

- **Control printing functions easily and efficiently with the Job Center and the HP Embedded Web Server.** Control the progress and priorities of your print jobs without walking to the printer. With batch printing, instead of opening individual files and changing their settings, drag and drop your batch of files to the Job Center² for easy reprinting. And, if you're copying, don't worry about losing time; copy jobs have priority over print jobs.

Intuitive, effortless operation

- **Easy operation saves training time and costs.** Even untrained users can easily master operation and immediately copy, scan, and print large-format documents by using the graphical touchscreen display and intuitive software.
- **Assume greater control over your final output.** Fast-preview advanced color and image-quality adjustment options not only ensure you get the expected quality with your very first copy, but also help improve the quality of damaged or weathered originals with a background cleaning option.
- **Boost productivity with preconfigured drivers and network connectivity—including scan-to-network functionality.** This MFP is fully compatible. Easily print scanned documents directly to almost any HP Designjet printer.³ Built-in scan-to-network capabilities foster productivity with fewer steps. Easily save scanned files in PDF, TIFF, JPEG 2000, and DWF file formats.
- **Easily maintain and manage this printer and its supplies with HP Easy Printer Care.**

Convenient, integrated single-vendor solution

- **Convenient single-vendor solution—built together to work together.** Bidirectional capabilities between the printer and scanner provide built-in intelligence, enabling you to get basic printer-status information and access the printer queue.
- **Integrated multifunction solution saves valuable workspace with a single footprint.**

¹ Using plain paper in best mode for a 36-in. color CAD original

² Files supported by HP-GL/2, CALS/G4

³ Fully compatible with HP Designjet 500, 800, 1000, 4000, 4500, 5000, 5500, T610, T1100, Z2100, Z3100, and Z6100 series printers

HP Designjet T1100 MFP

1. Scanning speed of 2 inches (50.8 mm) per second for color and 6 inches (152 mm) per second for mono originals (400 dpi Turbo)
2. Print A1 (D)-sized documents in 35 seconds per page
3. 15-inch touchscreen graphical display for easy, intuitive operation
4. Fast preview enables greater control over final output
5. DVD/CD reader/writer to save files directly to disc
6. Built-in fast image processing for excellent copy and scan performance
7. Intuitive software provides easy-to-use scanning, copying, and network printing
8. The integrated product design saves workspace
9. Print output basket for high volume batch jobs
10. High scanning quality and speeds, excellent 3D scanning capability

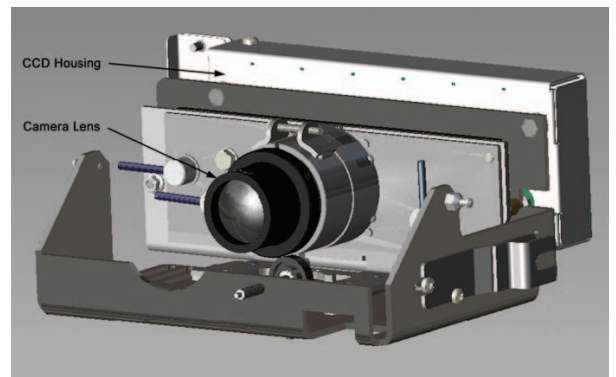

vivera
HP INKS

- Accurate color
- Dark blacks
- True neutral grays
- Smooth area fills
- Subtle contrasts, from the most vivid color to the softest tones

Triple 4-linear CCDs camera scanning technology

- Superior scanning quality: Color CCD technology includes three digital cameras with four arrays with RGB filters that separate color components and panchromatic BW filter to ensure superior quality on grayscale
- High application versatility
- Better results with previously folded paper
- Lower maintenance costs: modular technology, many customer-replaceable parts
- Can reach high scanning speeds thanks to powerful illumination and processing capabilities
- More tolerant to dust

“The HP Designjet T1100 MFP not only scans and prints at amazing speeds, it includes a host of convenient job management features—like batch printing, queue management, scan to PDF and scan to network—that really save time and greatly simplify our workflow.”

– Peter Frode Vandrup—Printer operator, Ramboll

Printing

Achieve professional prints with a wide range of color and fine details.

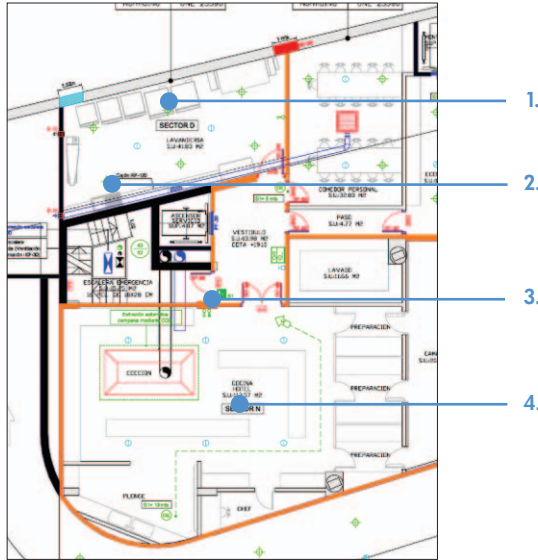

1. Uniform lines
2. Neutral grays and deep blacks
3. Accurate color
4. Crisp text

Copying

See impressive accuracy for any kind of original.

Settings specially optimized for:

- CAD
- Map
- Brochure (line and text)
- Photo

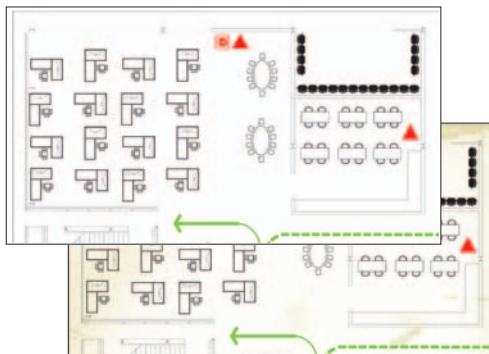

Improved quality for damaged document thanks to the background cleaning feature

Scanning

Scan to many different locations.



CD/DVD

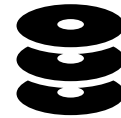

Scanner and hard drive

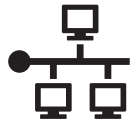

Network

Scan original up to 0.6 inches thick

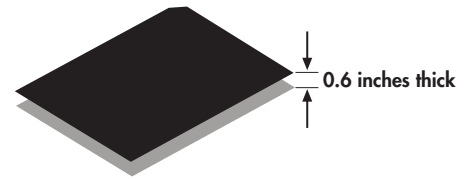

Scan to many industry standard formats



Intuitive Software

Touchscreen fast preview ensures greater control over final output

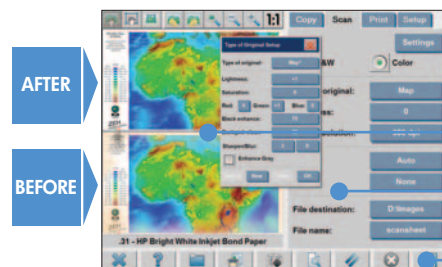

1. Preview window

2. Control section

3. Tool bar

HP Designjet T1100 MFP

Technical specifications

Print	
Print speed ¹	Line drawings: 35 sec D/A1 on plain media in Fast Economode, 52 D/A1 per hour on plain media in Fast mode Color images: 445 f ² /hr (41 m ² /hr) on coated media in Fast mode, 30 f ² /hr (2.8 m ² /hr) on glossy media in Best mode
Print resolution maximum	2400 x 1200 optimized dpi
Margins	Roll: 0.2 x 0.2 x 0.2 x 0.2 in./5 x 5 x 5 mm (borderless on photo papers) Sheet: 0.2 x 0.67 x 0.2 x 0.2 in./5 x 16.75 x 5 x 5 mm
Technology	HP Thermal Inkjet
Print cartridge colors	Cyan, gray, magenta, matte black, photo black, yellow
Ink types	HP Vivera inks
Ink drop	6 pl (cyan, magenta, photo black, gray), 9 pl (yellow, matte black)
Ink cartridge size	69 ml (photo black, cyan, magenta, yellow, gray) 130 ml (matte black, photo black, cyan, magenta, yellow, gray)
Minimum line width	0.002 in./0.0423 mm
Line accuracy	+/- 0.1% ²
Scan	
Scan speed	Color (200 dpi/400 dpi Turbo): 2 in./sec (51 mm/sec) Black-and-white (200 dpi/400 dpi Turbo): 6 in./sec (152 mm/sec)
Scan/copy resolution	Enhanced mode: 9600 x 9600 dpi with variable resolution settings from 50 dpi in increments of 1 dpi Best mode: color and black-and-white: 300 x 300 dpi Normal mode: color and black-and-white: 200 x 200 dpi Draft mode: color and black-and-white: 150 x 150 dpi
Maximum scan width	42 in. (1067 mm)
Maximum scan thickness	0.6 in. (15 mm)
Line accuracy	+/- 0.3% (Y axis), +/- 0.1% (X axis)
Copy	
Reduction/enlargement	1 to 10000%
Maximum copies	1000 copies
Copier settings	Type of original, image crop and align preview, lightness, saturation and RGB controls, sharpen/blur, mirror copy, enlarge/reduce, paneling, tiling, nesting, accounting, batch
Media handling	
Printer	Roll feed, sheet feed, automatic cutter
Scanner	Sheet feed
Media types	
Printer	Bond and coated paper (bond, coated, heavyweight coated, super heavyweight coated, super heavyweight plus matte, colored), photographic paper (satin, gloss, semi-gloss, matte, high-gloss), technical paper (natural tracing, translucent bond, vellum), film (clear, matte, polyester), backlit material, self-adhesive material (two-view cling, indoor paper, polypropylene, vinyl)
Scanner	Non-abrasive paper, vellum, mylar, sepia, blueprints, plastic film, plastic laminate, foam board, cardboard. (No plywood, stone plates, metal plates or abrasive, dirty, rough, sharp-edged, metal-clamped, burned surfaces, or transparencies)
Processing and memory	
Printer	Intel® Centrino™ mobile 600 MHz, 256 MB memory, 40 GB hard disk
Scanner	Intel Pentium 4 2.8 GHz, 1 GB memory, 40 GB hard disk
Connectivity	
Interfaces (standard)	Printer: One 10/100/1000BT Ethernet RJ-45 port, one Hi-Speed USB 2.0 certified port, one EIO Jetdirect accessory slot Scanner: One 10/100BT Ethernet RJ-45 port, one Hi-Speed USB 2.0 certified port, one FireWire®
Print languages	Adobe® PostScript® 3™, Adobe PDF 1.6, HP-GL2/RTL, CALS/G4, TIFF, JPEG, HP PCL 3 GUI
Drivers (included)	HP-GL/2, HP-RTL Windows® drivers; PS Windows drivers; Optimized Windows driver for AutoCAD 2000 and higher; support for Citrix MetaFrame environments; PS driver for Mac® OS X
Environmental ranges	
Operating temperature	41 to 104° F/5 to 40° C
Recommended operating temperature	64 to 90° F/18 to 32° C
Storage temperature	-4 to 131° F/-20 to 55° C
Operating humidity	20 to 80% RH
Acoustic	
Sound pressure, active	55 dB(A)
Sound pressure, standby	42 dB(A)
Sound power, active	6.9 B(A)
Sound power, standby	5.8 B(A)
Power consumption	
Maximum	330 watts
Powersave	44.4 watts
Off	1.69 watts
Power requirements	Input voltage (auto-ranging): 100 to 240 VAC (+/- 10%), 50/60 Hz (+/- 3 Hz), 2 amp max

For more information, visit our website at www.hp.com/go/designjetT1100MFP



¹ Mechanical printing time
² ±0.1% of the specified vector length or ±0.1 mm (whichever greater) at 23° C (73° F), 50-60% relative humidity, on E/A0 printing material in Best or Normal mode with HP Matte Film

© 2008 Hewlett-Packard Development Company, L.P. The information contained herein is subject to change without notice. The only warranties for HP products and services are set forth in the express warranty statements accompanying such products and services. Nothing herein should be construed as constituting an additional warranty. HP shall not be liable for technical or editorial errors or omissions contained herein. Adobe and Adobe Postscript 3 are trademarks of Adobe Systems Incorporated. Intel, Pentium and Intel Centrino are trademarks or registered trademarks of Intel Corporation or its subsidiaries in the United States and other countries. Microsoft and Windows are U.S. registered trademarks of Microsoft Corporation. Windows Vista is either a registered trademark or trademark of Microsoft Corporation in the United States and/or other countries.

4AA1-5007ENUC Rev. 2, February 2008

Certification	
Safety	Compliant with ITE requirements including USA and Canada (CSA certified), EU (LVD and EN60950-1 compliant), Russia (GOST), Singapore (PSB), China (CCC), Argentina (IRAM)
Electromagnetic	Compliance for Class A ITE products: EU (EMC Directive), USA (FCC Rules), Canada (DoC), Australia (ACA), New Zealand (MoC), China (CCC), Japan (VCCI); Certified as Class A product: Korea (MIC), Taiwan (BSMI)
Environmental	RoHS, WEEE
Warranty	One-year, next business day, on-site warranty

HP Care Pack Services	
H4518E	HP Installation with Network Configuration
UH467E	HP 3-year Next Business Day Onsite Hardware Support
UH468E	HP 4-year Next Business Day Onsite Hardware Support
UH469E	HP 5-year Next Business Day Onsite Hardware Support
UH476PE	HP 1-year Post-Warranty Next Business Day Onsite Hardware Support

Dimensions (w x d x h)	
MFP	74.8 x 39.4 x 63.0 in./1900 x 1000 x 1600 mm
Shipping	77.6 x 31.1 x 57.1 in./1970 x 790 x 1450 mm
Weight	
MFP	455.3 lb/ 202.5 kg
Shipping	594 lb/ 269.5 kg

What's in the box
Printer, printheads (3 x 2 colors each), introductory ink cartridges, coated paper sample roll (24 in. x 25 ft), 44-inch stand, 44-inch rear tray, 3-inch spindle adaptor kit, quick reference guide, setup poster, legal document, doc and drivers DVD, Autodesk Design Review CD, customer service guide, Ethernet cable, printer power cord, scanner, scanner stand, panel PC, calibration sheet, plastic dust cover, A2 protection transparent sheet, system recovery DVD, keyboard, maintenance kit, assembly kit, USB cable, FireWire cable, scanner power cord

Ordering Information

Product	
Q6713A	HP Designjet T1100 MFP
Accessories	
Q6709A	HP Designjet Tx100/Tx10 44-inch Spindle
J7934G	HP Jetdirect 620n Fast Ethernet Print Server
J7997G	HP Jetdirect 630n IPv6 Gigabit Print Server
J7961G	HP Jetdirect 635n IPv6/IPv4 Print Server
Original HP printheads	
C9380A	HP 72 Gray and Photo Black Printhead
C9383A	HP 72 Magenta and Cyan Printhead
C9384A	HP 72 Matte Black and Yellow Printhead
Original HP ink cartridges with HP Vivera inks	
C9397A	HP 72 69-ml Photo Black Ink Cartridge
C9398A	HP 72 69-ml Cyan Ink Cartridge
C9399A	HP 72 69-ml Magenta Ink Cartridge
C9400A	HP 72 69-ml Yellow Ink Cartridge
C9401A	HP 72 69-ml Gray Ink Cartridge
C9403A	HP 72 130-ml Matte Black Ink Cartridge
C9370A	HP 72 130-ml Photo Black Ink Cartridge
C9371A	HP 72 130-ml Cyan Ink Cartridge
C9372A	HP 72 130-ml Magenta Ink Cartridge
C9373A	HP 72 130-ml Yellow Ink Cartridge
C9374A	HP 72 130-ml Gray Ink Cartridge
Original HP media	
Q6627A	HP Super Heavyweight Plus Matte Paper 36 in. x 100 ft/914 mm x 30.5 m
Q6628A	HP Super Heavyweight Plus Matte Paper 42 in. x 100 ft/1067 mm x 30.5 m
C6030C	HP Heavyweight Coated Paper 36 in. x 100 ft/914 mm x 30.5 m
C6569C	HP Heavyweight Coated Paper 42 in. x 100 ft/1067 mm x 30.5 m
Q1956A	HP Heavyweight Coated Paper 42 in. x 225 ft/1067 mm x 67.5 m
C6019B	HP Coated Paper 24 in. x 150 ft/610 mm x 45.7 m
C6020B	HP Coated Paper 36 in. x 150 ft/914 mm x 45.7 m
C6980A	HP Coated Paper 36 in. x 300 ft/914 mm x 91.4 m
C6810A	HP Bright White Inkjet Bond Paper 36 in. x 300 ft/914 mm x 91.4 m
Q1397A	HP Universal Inkjet Bond Paper 36 in. x 150 ft/914 mm x 45.7 m
C3868A	HP Natural Tracing Paper 36 in. x 150 ft/914 mm x 45.7 m
C3875A	HP Clear Film 36 in. x 75 ft/914 mm x 22.9 m
51642B	HP Matte Film 36 in. x 125 ft/914 mm x 38.1 m
Q1427A	HP Universal High-gloss Photo Paper 36 in. x 100 ft/914 mm x 30.5 m
Q1421A	HP Universal Semi-gloss Photo Paper 36 in. x 100 ft/914 mm x 30.5 m
Q8834A	HP Universal Self-adhesive Gloss Polypropylene 36 in. x 75 ft/914 mm x 22.9 m

More HP media sizes and weights available at www.hp.com/go/designjet/supplies

